

märklin
mini-club

8998

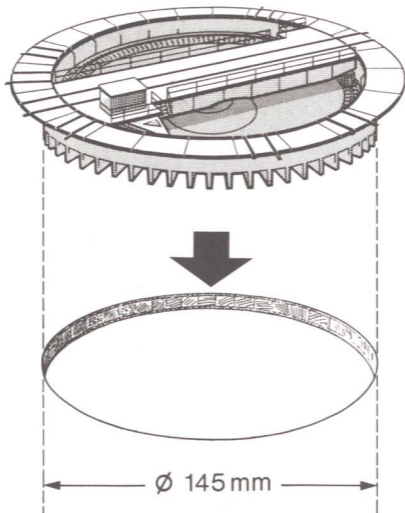

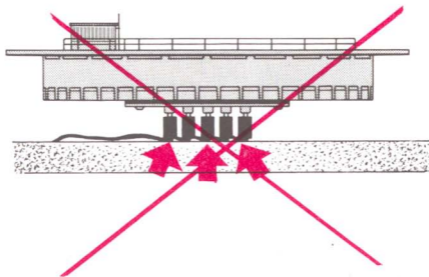

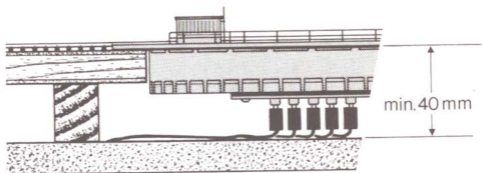
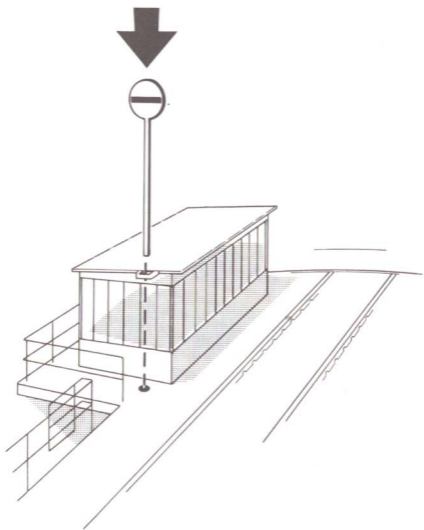

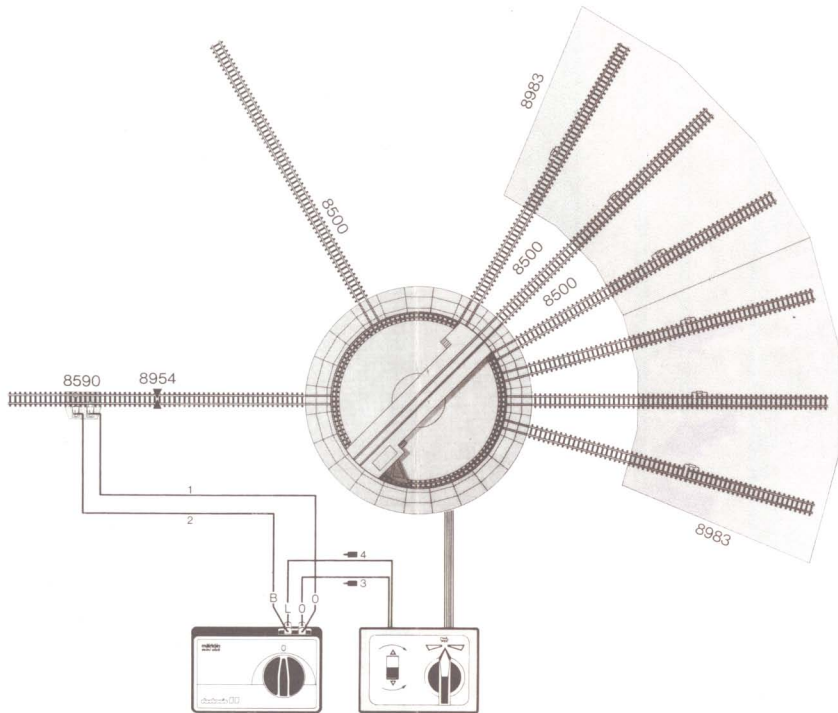

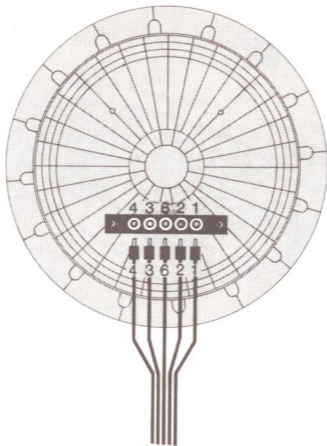

- 1 = braun · brown · brun · bruin · marrón · marrone · brun · brun
 2 = rot · red · rouge · rood · rojo · rosso · röd · rød
 3 = grau · gray · gris · grijs · gris · grigio · grå · grå
 4 = gelb · yellow · jaune · geel · amarillo · giallo · gul · gul
 6 = grün · green · verte · groen · verde · verde · grøn · grøn

[alternative page from another version of the booklet showing blue and violet colored wires - courtesy Larry D.]

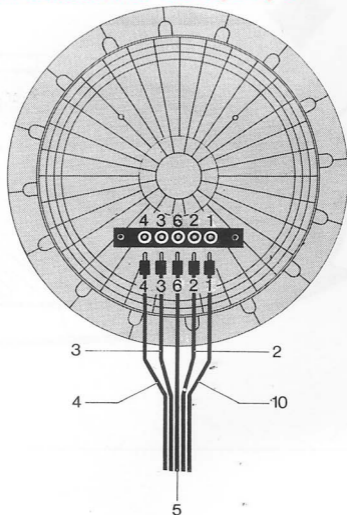

- 1 = braun · brown · brun · bruin · marrón · marrone · brun · brun
- 2 = rot · red · rouge · rood · rojo · rosso · röd · rød
- 3 = grau · gray · gris · grijs · gris · grigio · grå · grå
- 4 = gelb · yellow · jaune · geel · amarillo · giallo · gul · gul
- 5 = blau · blue · bleu · blauw · azul · blu · blå · blå
- 6 = grün · green · verte · groen · verde · verde · grön · grøn
- 10 = violett · violet · violet · violet · violeta · violetto · violett · violet

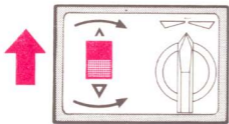
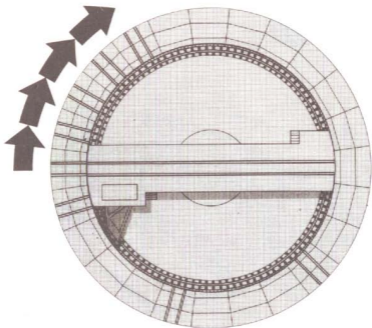

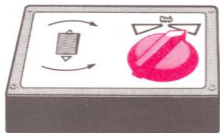
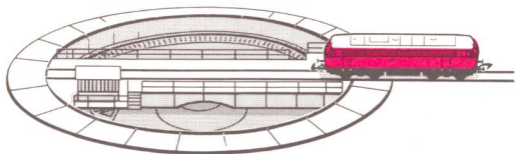

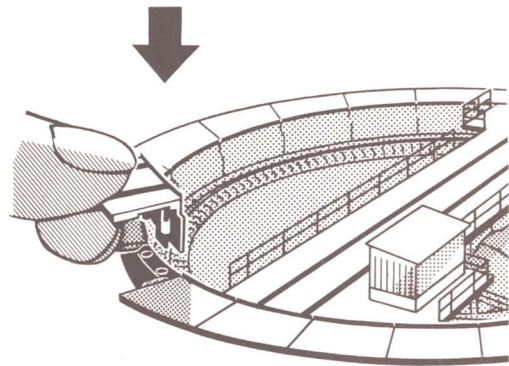
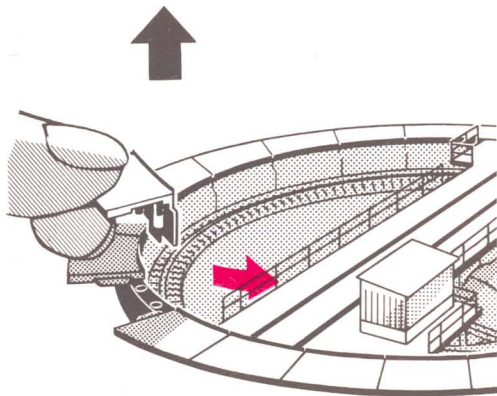
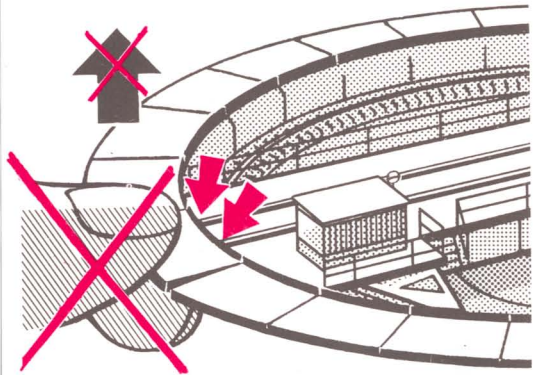

8997





